

MOTOR SPECIFICATIONS:

MOTOR TECH SPECS

- 8 POLE
- 1175 KV
- 45,000 RPM MAX

MECHANICAL SPECS

- OAL: 97MM
- DIAMETER: 45MM
- SHAFT LENGTH: 41MM
- SHAFT DIAMETER: 6MM
- MOUNTING OPTIONS
 - M3 THREAD ON 25MM BOLT CIRCLE
 - M4 THREAD ON 30MM BOLT CIRCLE
- WEIGHT: 361.2 g (12.75 OZ)

WIRE AND BULLETS

- 13 AWG, SILICONE WIRE, BLACK, WHITE, RED, 150MM LONG
- 5.5MM CC BULLETS (FEMALES INCLUDED IN PACKAGING)

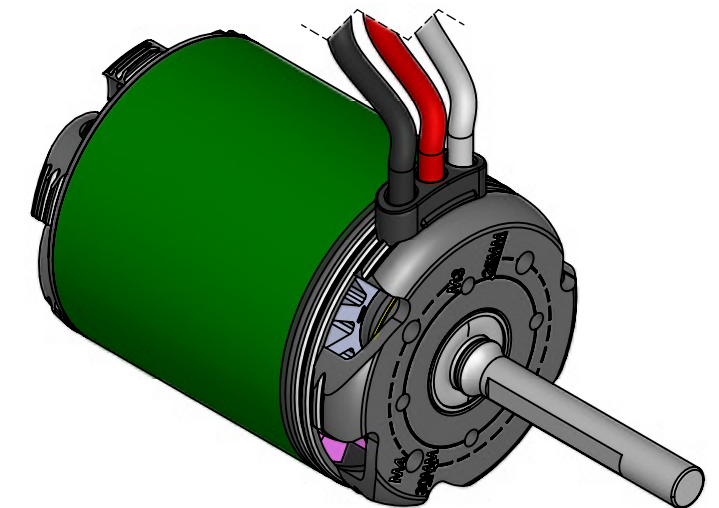
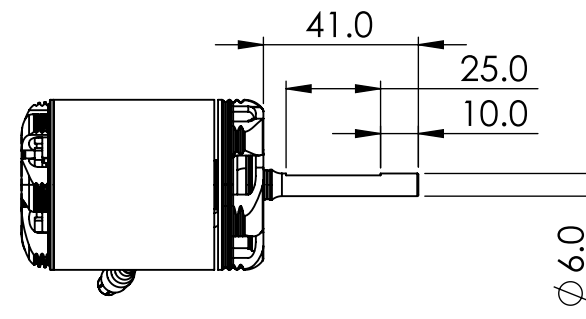

UNLESS OTHERWISE SPECIFIED:

DIMENSIONS ARE IN MILLIMETERS (INCHES)

TOLERANCES:

ANGULAR: MACH $\pm 0.5^\circ$ BEND $\pm 1^\circ$

ONE PLACE DECIMAL ± 0.2

TWO PLACE DECIMAL ± 0.1

TITLE:

DRAWN: JCV

DATE: 01/22/2013

MATERIAL

FINISH

DO NOT SCALE DRAWING

SIZE | DWG. NO.

B | Vertigo 550 W3530 FINAL

SCALE: 1:2

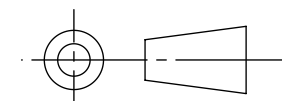

PROPRIETARY AND CONFIDENTIAL
THE INFORMATION CONTAINED IN THIS DRAWING IS THE SOLE PROPERTY OF CASTLE CREATIONS. ANY REPRODUCTION IN PART OR AS A WHOLE WITHOUT THE WRITTEN PERMISSION OF CASTLE CREATIONS IS PROHIBITED.

castle creations, inc.